

S-050 DN20

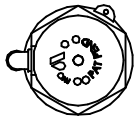

S-050 DN25

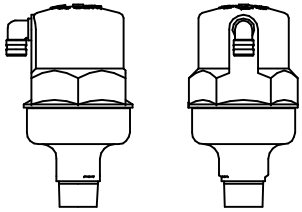
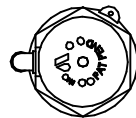
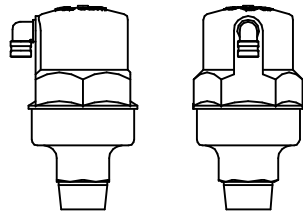

S-050-C DN20

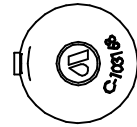
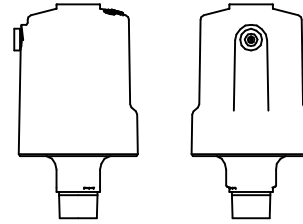

S-050 ONE WAY IN/OUT DN20

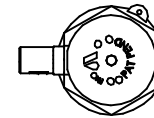
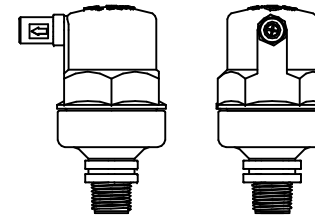

S-050 TAP DN25

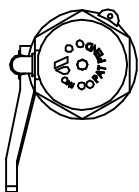
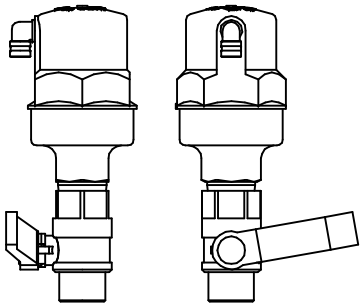

S-050 TAP&FLANGE DN25

